

High power LED T Bulb 50 W E27

When compared to traditional high-intensity discharge (HID) bulbs, our high-power LED bulbs save more than 80% of the energy, and you get the benefits of LEDs in terms of energy efficiency and long life, as well as immediate savings and a lower initial investment. With the correct lamp size and light distribution, you can easily install high-power LED bulbs and bypass the existing ballast while boosting lighting quality.



Product data

General information	
Socket	E27
LED type	SMD
Nominal lifetime	25 000 h
Number of switch cycles	X 12500
Dimmable	No
Light characteristic	
Beam angle	200 °
Nominal luminous flux	≥ 4500 lm
Efficacy	≥ 90 lm/W
Temperature of correlated color	4000 – 8000 k (According to choice)
Color rendering index	80
Electrical features	
Input voltage	220 – 240 V
Input frequency	50 Hz
Input power	50 W
Wattage equivalent	270 W
Nominal start time	0.5 s
Temperature	
Operating temperature	-20 to +40 °C
Standards	
Energy Efficiency Class	A+
Package data	
Package dimensions	140 x 140 x 230 mm
Pieces per box	20



LIGHT IS LED

High power LED T Bulb 50 W E27

Dimensional drawing

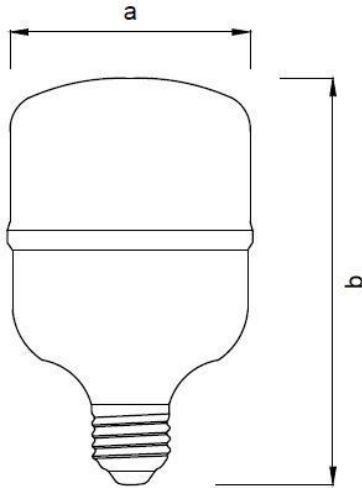

Energy efficiency label

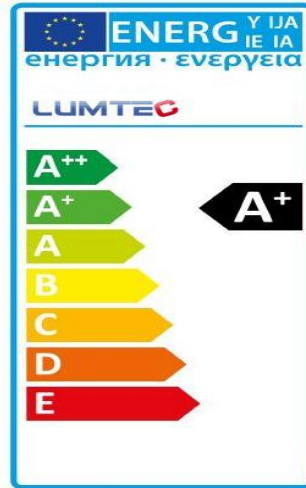

Product	a	b
High power LED T Bulb 50 W E27	138 mm	218 mm

Photometric

Spectrum

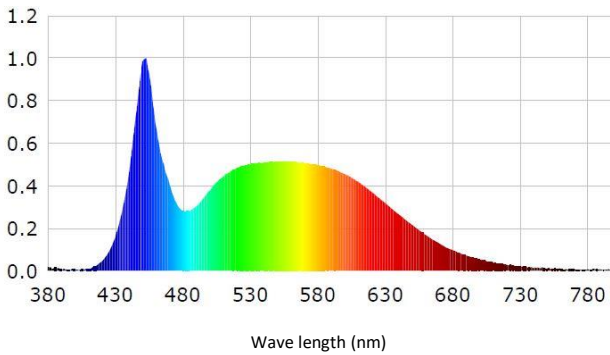

Life time

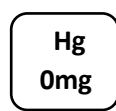
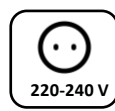
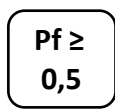
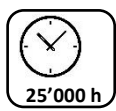
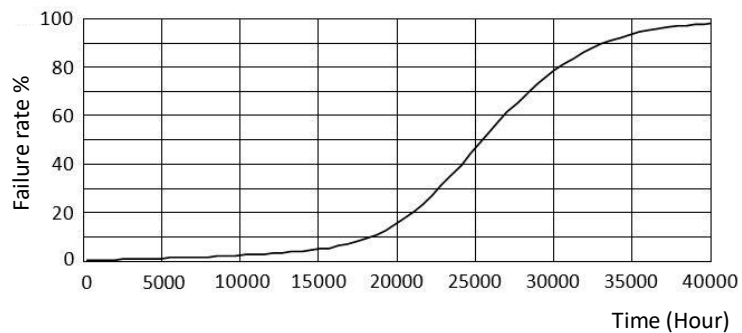

Id : 9105023295



LIGHT IS LED



www.lumtec.tn



Contact@lumtec.tn

Contact@kacem-electronic.com