

Recessed round Led panel 9 W



The recessed square Led panel is formed with optical lenses on each Led ensuring a unified distribution of light. This type of panel is also easy to install, which is why it is found in various applications such as at a house, office, restaurant, hotel, supermarket, and so on.

Product data

General information	
LED type	SMD
Nominal lifetime	25 000 h
Number of switch cycles	X 12500
Dimmable	No
Light characteristic	
Beam angle	120 °
Nominal luminous flux	≥ 720 lm
Efficacy	≥ 80 lm/W
Temperature of correlated color	4000 – 8000 k (According to choice)
Color rendering index	80
Electrical features	
Input voltage	220 – 240 V
Input frequency	50 Hz
Absorbed power	9 W
Power factor	≥ 0.5
Temperature	
Operating temperature	-20 to +40 °C
Standards	
Energy Efficiency Class	A+
Package data	
Package dimentions	128 x 35 x 126 mm
Packaging by box	40

Recessed round Led panel 9 W

Dimensional drawing

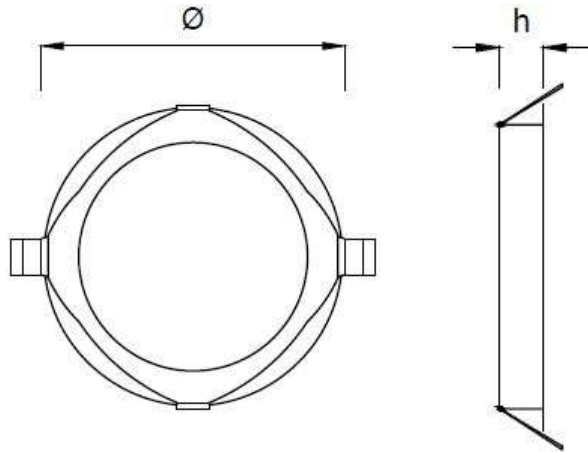

Energy efficiency label

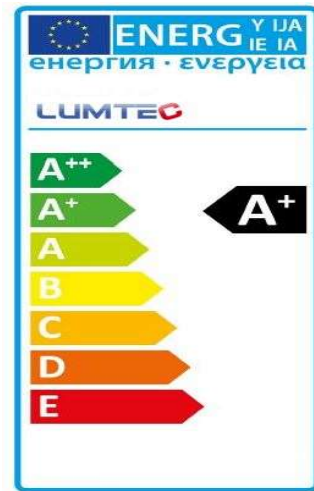

Product	Φ	h
Recessed round led panel 9 w	120 mm	24 mm

Photometric

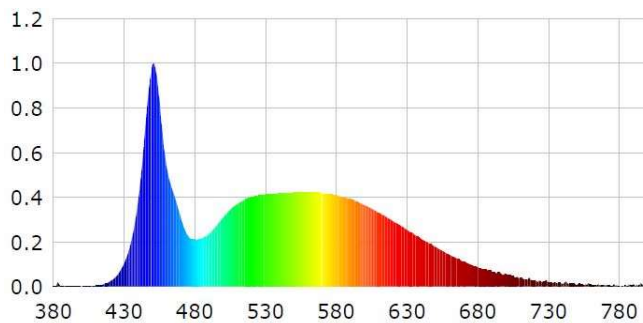

Life time

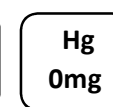
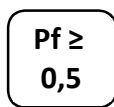
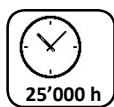
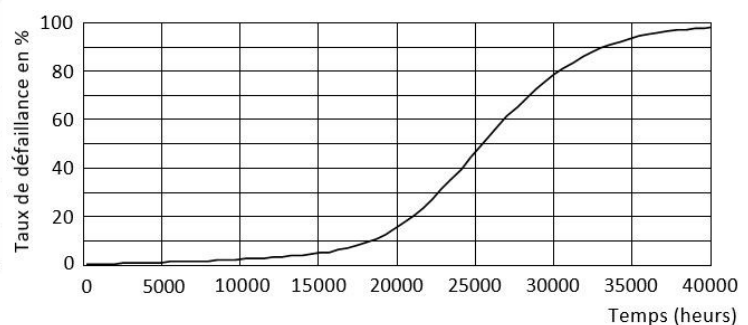

Id : 9105023295



LUMTEC®
LIGHT IS LED

www.lumtec.tn
Contact@lumtec.tn
Contact@kacem-electronic.com